

OR BSM E6 C

ORTA Tap Range Orta Bath Shower Mixer Eco6 Chrome



Features:

- Supplied with metal handles
- Supplied with metal backnuts
- Chrome plated to BS EN 248
- Supplied with rub clean handset, 1.75m hose & wall bracket
- Product supplied with either a 6 or 8 litre per minute flow regulator which can be fitted to the shower hose outlet to reduce water consumption and increase water efficiency (Flow Regulator accurate +/- 10%)

Product Certifications:



For more products, visit our website:
<http://www.bristan.com>



Specification

Product Type:	Taps
Main Construction Material:	Brass
Mount Type:	Deck
Handle Type:	Lever
Connection Inlet:	3/4" BSP Threaded Tails
Connection Outlet:	Flow Straightener
Number of Tap Holes:	2
Valve/Cartridge Type:	3/4" Ceramic Disc Valve - 1/4 turn
Plumbing System Requirements:	Suitable for all plumbing systems
Minimum Dynamic Pressure (bar):	0.2 bar
Maximum Dynamic Pressure (bar):	5.0 bar
Maximum Hot Water Temperature °C:	65°C
Maximum Static Pressure (bar):	10 bar
Flow Type:	Single
Isolation Included:	No

Dimensions (measurements in mm)

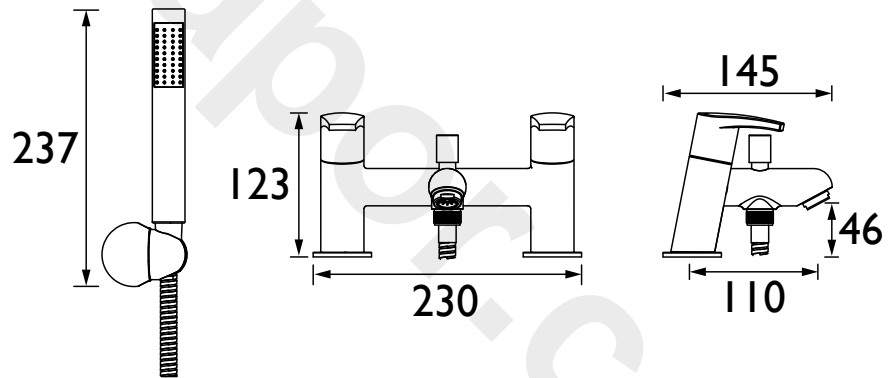

Flow Rates (l/min)

System Pressure (bar)	0.2	0.5	1	2	3	5
Through Bath Filler (mixed)	18.4	29.1	41.2	58.2	71.3	92
Through Handset (mixed)	6	6	6	6	6	6

TECHNICAL DATA SHEET



BRISTAN

D3